

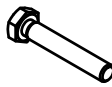

- (4X) 
- (4X) 
- (4X) 



392167

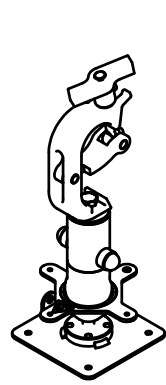
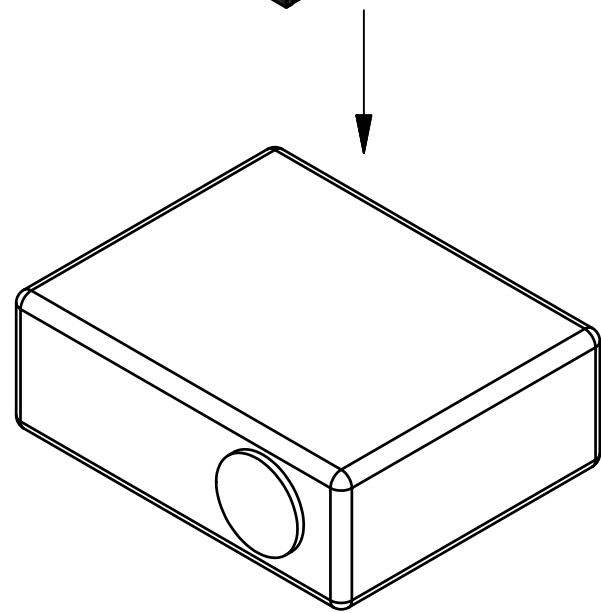
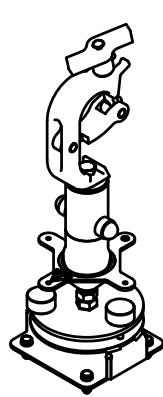

392367

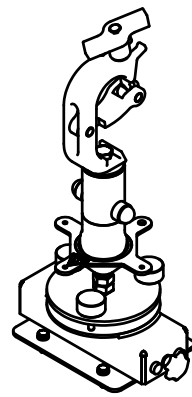

392667

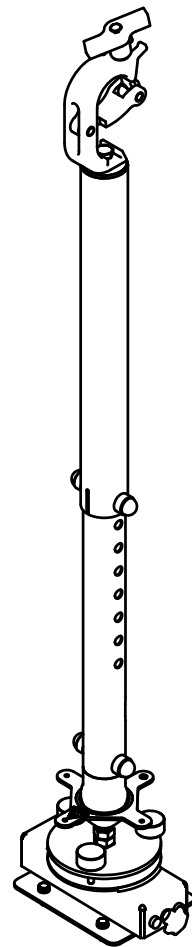

392666

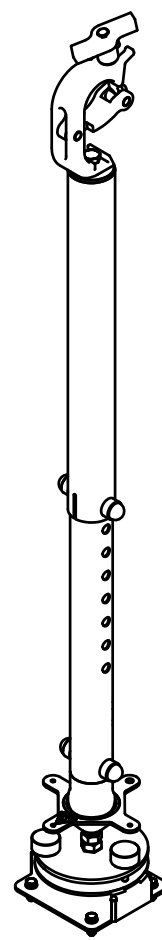

392366

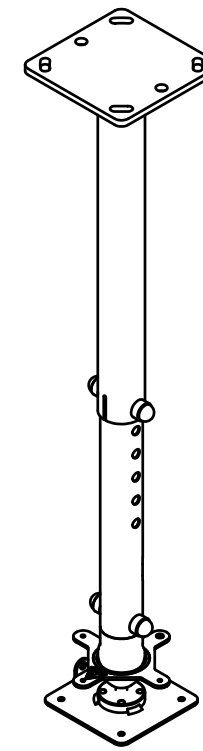

392161

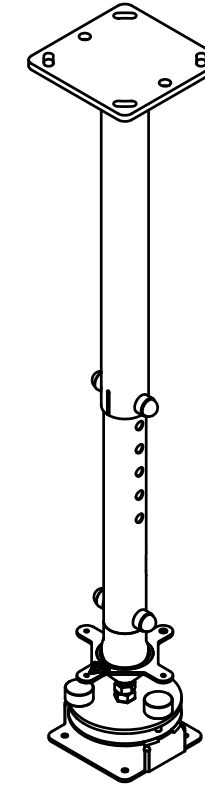

392361

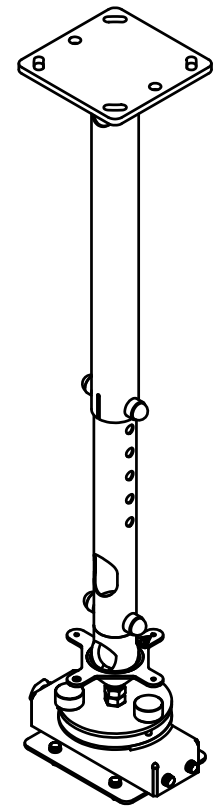

392661

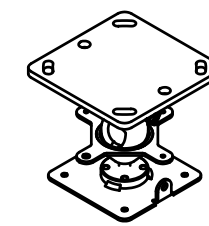

392165

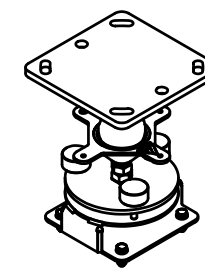

392365

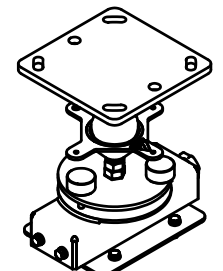

392665

NOTE: All dimensions are ±..., in mm and subject to change

© COPYRIGHT AUDIPACK  
 This print and the information shown  
 thereon, is the property of  
 AUDIPACK.  
 It may not be delivered to others nor  
 reproduced for general circulation  
 without the written consent of the  
 AUDIPACK engineering department.



**AUDIPACK**  
 Industriestraat 2-4  
 2751 GT Moerkapelle  
 the Netherlands  
 Tel: +31(0)795931671  
 Fax: +31(0)795933115  
 www.audipack.com

MANUAL  
 392411

PROJECTOR MOUNT

Dimensions are indications, not to be used for any preparations. No rights can be derived from the above dimensions.