

PROJECTOR POP-UP LIFT M- SERIES

Mounting instructions





Safety instructions:

- Check the unit for damages caused by transport. In case of damage please report directly to the transporter and Audipack to provide a quick solution.
- Read the manual carefully before installing.
- Never install the product on more weight than it is allowed.
- Unplug before maintenance works.
- Please keep this manual for later use.

Index



Table of Contents

1	General features (Algemeen)	4
1.1	Technical data	4
1.2	Scope of delivery	4
1.3	Accessories.....	4
2	Required for installation	5
2.1	Mounting experiences	5
3	Mounting the product.....	6
3.1	Mounting in furniture.....	7
4	Connecting the PCB	9
4.1	Direction keys	9
4.2	Limit Switch	9
4.3	Connector 1 (power supply)	10
4.4	Motor.....	10
4.5	Optional IR / RF remote control.....	10
4.6	Replacing loop for a safety stop.....	11
4.7	External control.....	12

Package of contents

1 General features

A projection system to place the projector on the pop-up lift in a cabinet, out of sight. The lift is driven by electric motor with a safety nut. The motor can only push, not pull. The safety nut stops the movement in the down direction when the lift is mechanically obstructed.

Specifications

1.1 Technical data

Primary power supply 100~240 VAC 50-60 Hz
External power supply 24 VDC 2,5A (included)
Suitable for wide screen 16:9 - 16:10 projectors

1.2 Scope of delivery

- (1X) Projector Pop-Up Lift
- (1X) Manual
- (1X) Power supply 261324
- (1X) Power cable 261325 (EU) of 261135 (UK)

Model:	Product code
M1-400	P0967
M1-500	P0674
M1-750	NA
M1-1000	NA
M2-900	P2960

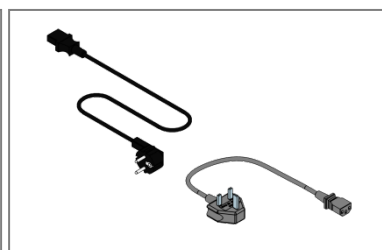
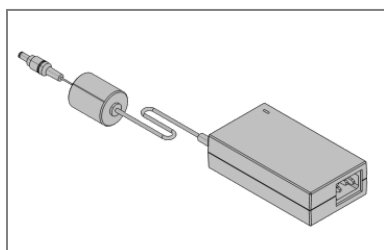
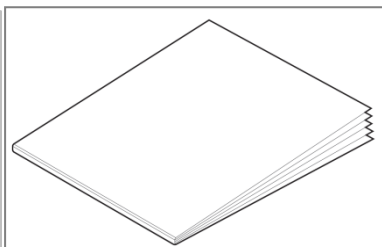
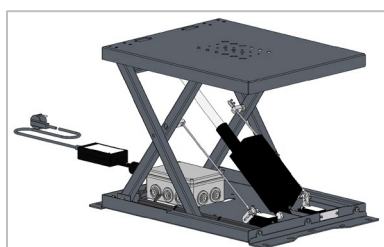

Package of contents

1.3 Accessories

- (1X) Audipack projector mount 39....
- (1X) Wireless remote set
- (1X) Rotary wall switch 261318

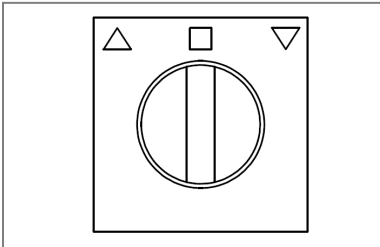
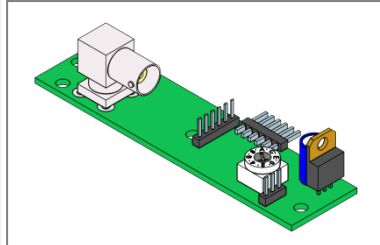
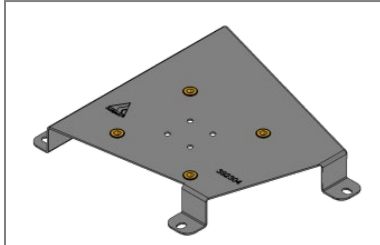



Mounting tools

2 Required for installation

For the installation of the lift you need at least the following mounting tools:

Om het product te kunnen installeren heeft u minimaal de volgende gereedschappen nodig:

<p>drill boormachine</p> 	<p>drill bit spiraalboor</p> 	<p>spirit level waterpas</p> 	<p>screwdriver schroevendraaier</p> 
<p>ring spanner ringsleutel</p> 	<p>ceiling fixing plafondbevestiging</p> 	<p>hand saw handzaag</p> 	<p>infrared measure infrarood meetlint</p> 

2.1 Mounting experiences

Please install the system with at least two installers. Never use damaged devices. Before mounting the system check the specifications on the label with those of the local power supply. Do all mounting and maintenance works with the power supply switched off.

Installeer het systeem met minstens twee installateurs. Gebruik nooit beschadigde apparaten. Graag alvorens de specificaties op het etiket van het systeem controleren en de stroomvoorzieningen. Zorg ervoor dat het systeem niet op het lichtnet is aangesloten bij het schoonmaken en het onderhouden van het systeem.

Mounting

3 Mounting the product

Mount the lift with minimal 4 bolts in the furniture.

$\geq 4x$	CONCRETE BETON BETON BETON DIN 16268 - M6x75		WOOD HOLZ BOIS HOLT DIN 571 - M6x80	
-----------	--	---	---	---

Make sure the lift is mounted level!



Mounting

3.1 Mounting in furniture

When the lift is mounted in a furniture make sure the maximum stroke of the lift does not pass the side panels of the furniture. This will prevent pinching of fingers etc.

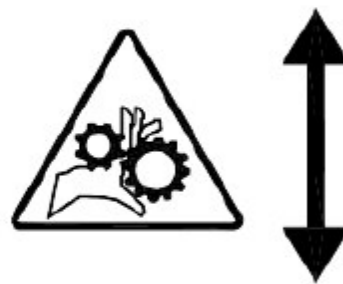
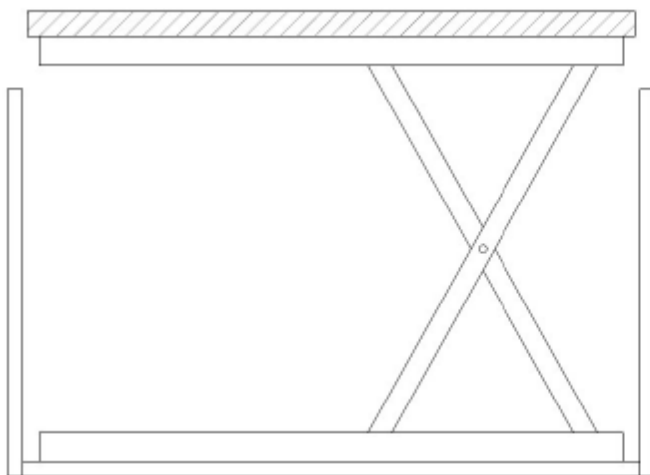

Keep at least 5 to 10 mm free between the moving and static parts of the furniture.

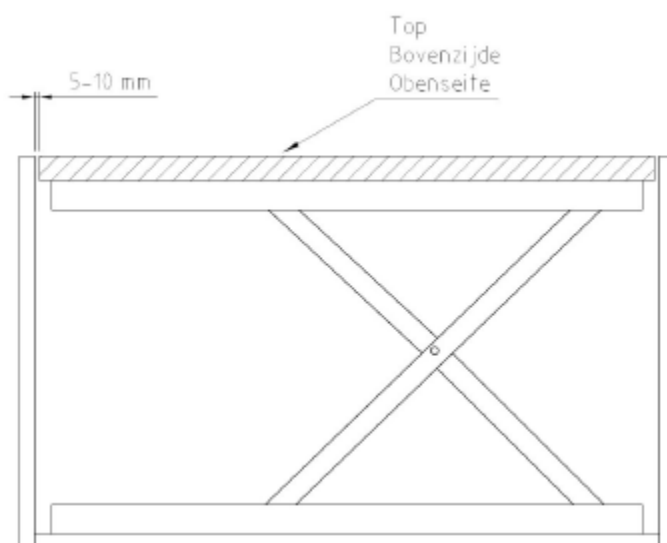

Settings

4 Setting the upper and down limits

For adjusting the start and end position the small keepers on the round rods can be moved to another position. The ones sealed with red must not to be used. These red keepers are for setting the mechanical limits.

NOTE: Removing these will result in ending the warranty.

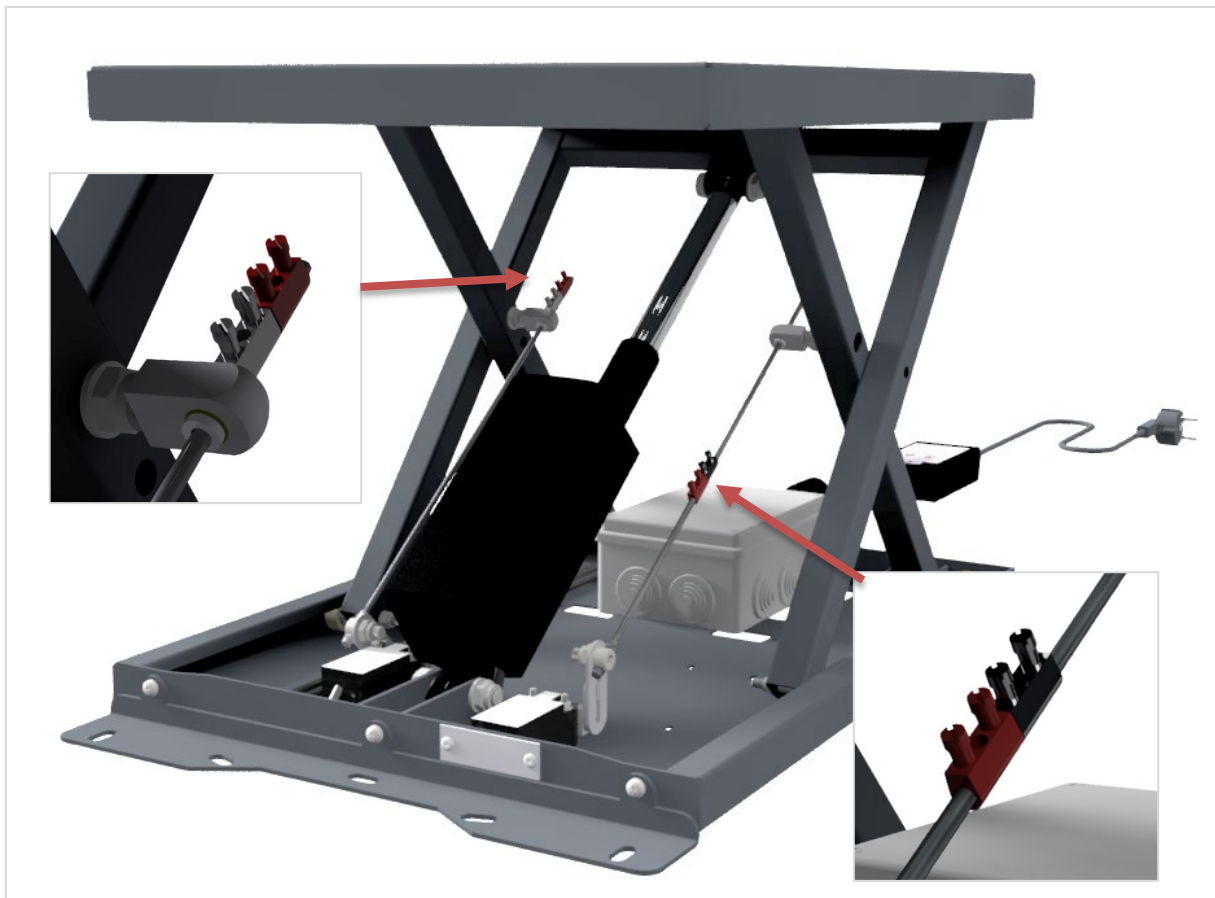

Electrical connections

5 Connecting the PCB

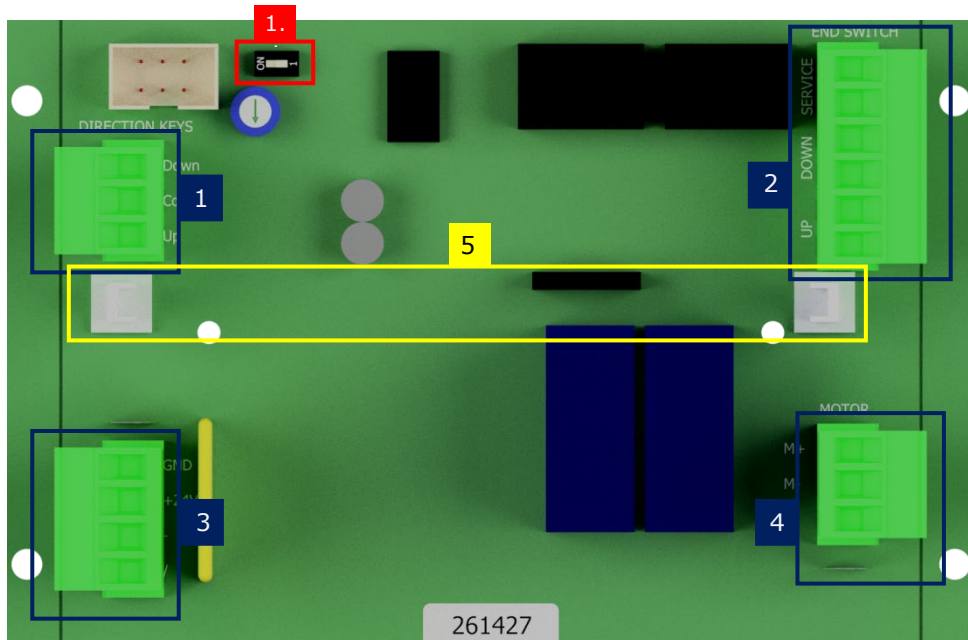

5.1 Direction keys

DOWN (open), COM and UP (close):

Connect to 2 separate relays (or optional wall Switch 261318)

Verbind deze connector met een 2 aparte relais uitgangen
(Of een optionele muurschakelaar 261318)

Use the dip switch (1.1) on the PCB for selecting auto run after pulse contact.

5.2 Limit Switch

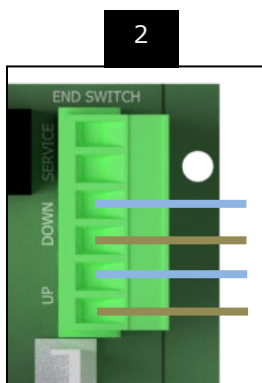

Service: Not Applicable

Lower limit: Connected to the lift down rod and switch
Aangesloten op de schakelstang en schakelaar lift laag

Upper limit:
Connected to lift up rod and switch
Aangesloten op de schakelstang en schakelaar lift hoog

Electrical connections

5.3 Connector 1 (power supply)

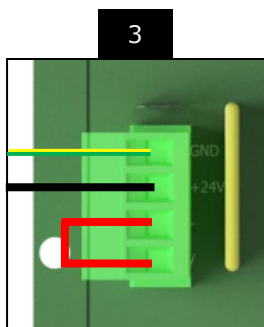

- - 24 volt (GND)
 - +24V
 - Loop
- (Option for safety switch)

5.4 Motor

M+/M-:

Is connected to the motor of the Lift
aangesloten op de motor van de MKT

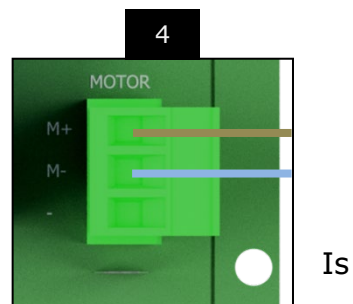

5.5 Optional IR / RF remote control

261436:

RF remote control set

RF-afstandsbediening set

(read remote instructions for setting up)

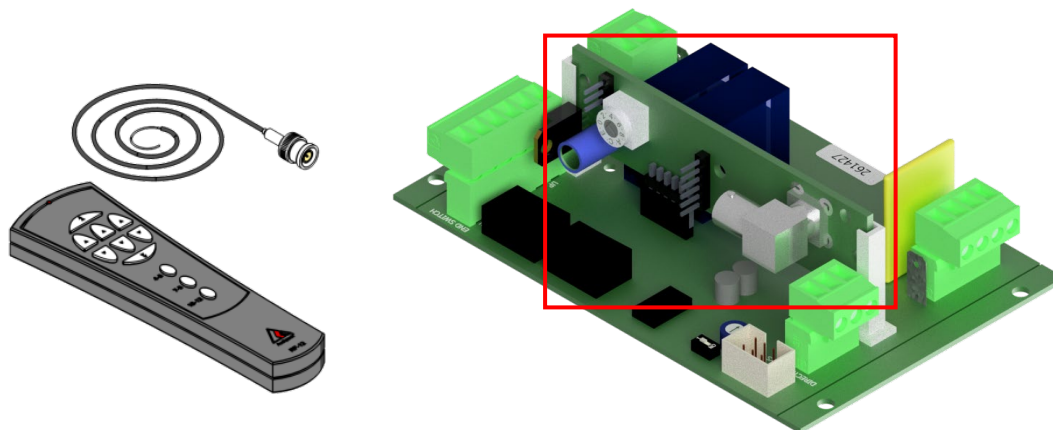

Electrical connections

5.6 Replacing loop for a safety stop

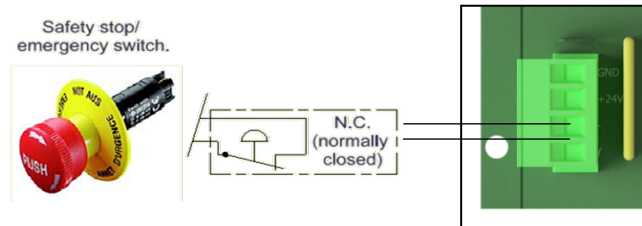

The loop connection can be replaced by a safety stop or emergency switch. Remove the loop completely to disconnect the power from the control board.

De aansluiting van de doorlusing kan worden vervangen door een noodstop of veiligheidsschakelaar. Bij het verwijderen van de loop, koppelt het los met de spanning van besturingsprint.

Electrical connections

5.7 External control

External control: control by relay.



WARNING:
The voltage on these wires can be 12-24 VDC and **230 VAC!**

Note: to control the system pulse or constant, and adjust the maximum power, please see 'appendix 261377 MOTOR CARD'.

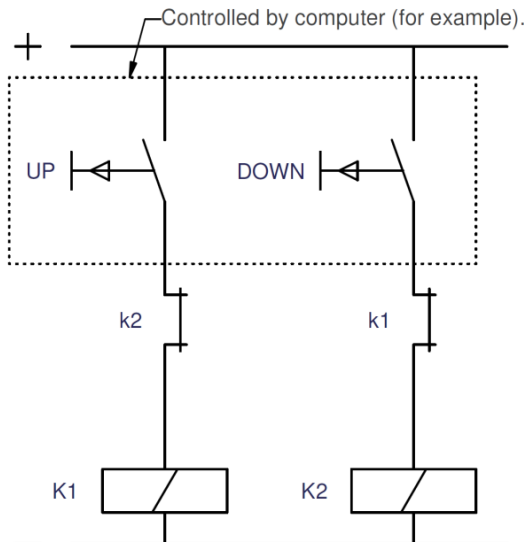

External cable control box

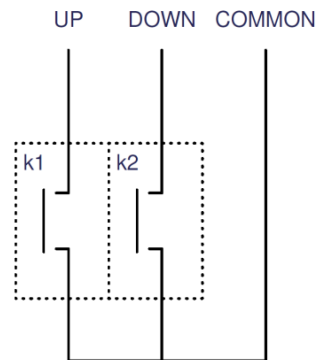

-K1 and K2 are relays.
-k1 and k2 are relays.

External control: control by wall switch.

External cable control box
(not the motor control box!)

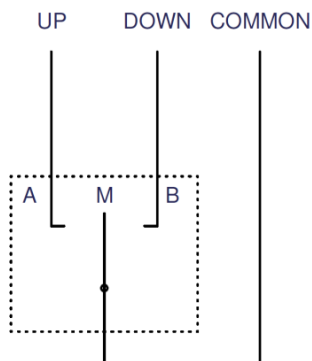

Wall switch
(with neutral position)
(not supplied)

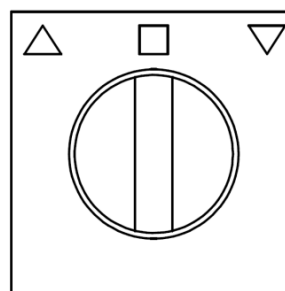

-A and B are potential free contacts.
-A: up or down.
-B: down or up.
-M: middle position (!).

Audipack's general conditions of sales and delivery apply to all of Audipack's deliveries. These conditions can be downloaded from Audipack's website, www.audipack.com, or will be send by post on request.

Audipack liefert ausschließlich unter die allgemeine Verkauf- und Lieferungsbedingungen von Audipack. Diese Bedingungen sind zum downloaden verfügbar auf die webseite von Audipack, www.audipack.com, oder werden Ihnen auf Anfrage per Post gesendet.

Alle leveringen geschieden uitsluitend volgens de Algemene Verkoop- en Leveringsvoorwaarden van Audipack. Een afschrift hiervan kunt u downloaden van de website van Audipack, www.audipack.com, of wordt u op aanvraag gestuurd per post.

Les conditions de Vente et de livraison de Audipack s'appliquent à tous les livraisons de Audipack. Cette conditions sont disponible sur le site internet de Audipack, www.audipack.com, où seront envoyé par poste sur demande.

AUDIPACK
Industriestraat 2-4
2751 GT Moerkapelle
The Netherlands

Tel: +31(0)795931671
Fax: +31(0)795933115
Email: audipack@audipack.com
www.audipack.com

Audipack reserves the right to make changes in specifications and other information contained in this document without prior written notice. The information provided herein is subject to change without notice. In no event shall Audipack be liable for any incidental, special, indirect, or consequential damages whatsoever, including but not limited to lost profits, arising out of or related to this manual or the information contained herein, even if Audipack has been advised of, known, or should have known, the possibility of such damages.