

Read the manual carefully before installing!

Lees aandachtig de gebruiksaanwijzing alvorens te beginnen met de installatie!

Bitte beobachten Sie den gebrauchsanleitung bevor Sie anfangen mit installieren!

S'il vous plaît, lisez attentivement le mode d'emploi avant commencer l'installation!

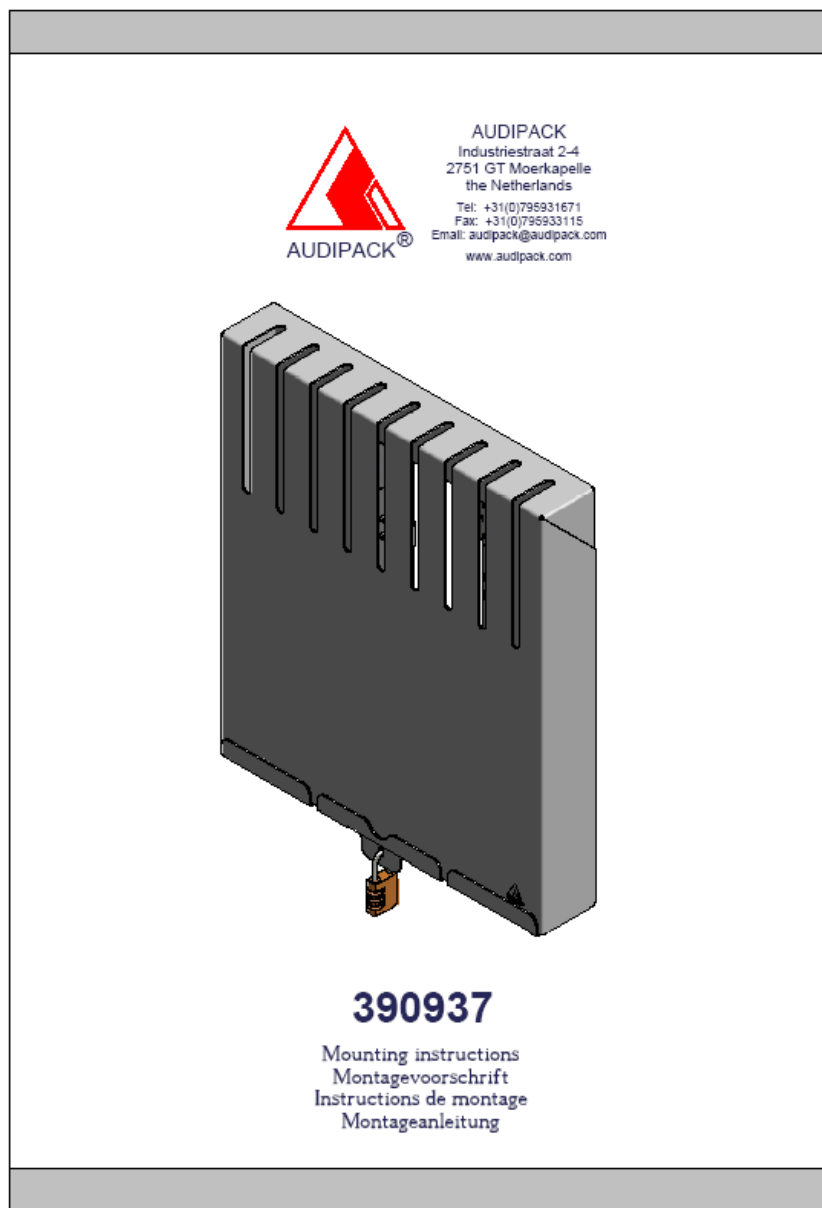

Audipack reserves the right to make changes in specifications and other information contained in this document without prior written notice. The information provided herein is subject to change without notice. In no event shall Audipack be liable for any incidental, special, indirect, or consequential damages whatsoever, including but not limited to lost profits, arising out of or related to this manual or the information contained herein, even if Audipack has been advised of, known, or should have known, the possibility of such damages.



AUDIPACK
Industriestraat 2-4
2751 GT Moerkapelle
the Netherlands
Tel: +31(0)795931671
Fax: +31(0)795933115
Email: audipack@audipack.com
www.audipack.com



AUDIPACK
Industriestraat 2-4
2751 GT Moerkapelle
the Netherlands
Tel: +31(0)795931671
Fax: +31(0)795933115
Email: audipack@audipack.com
www.audipack.com

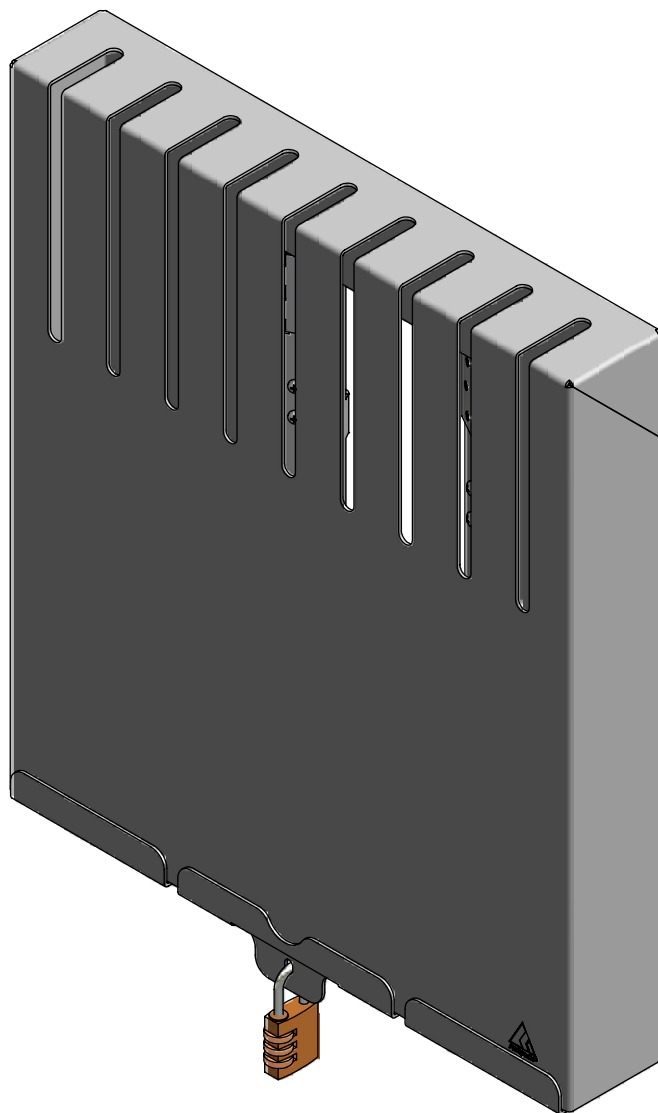

390937

Mounting instructions
Montagevoorschrift
Instructions de montage
Montageanleitung

1.

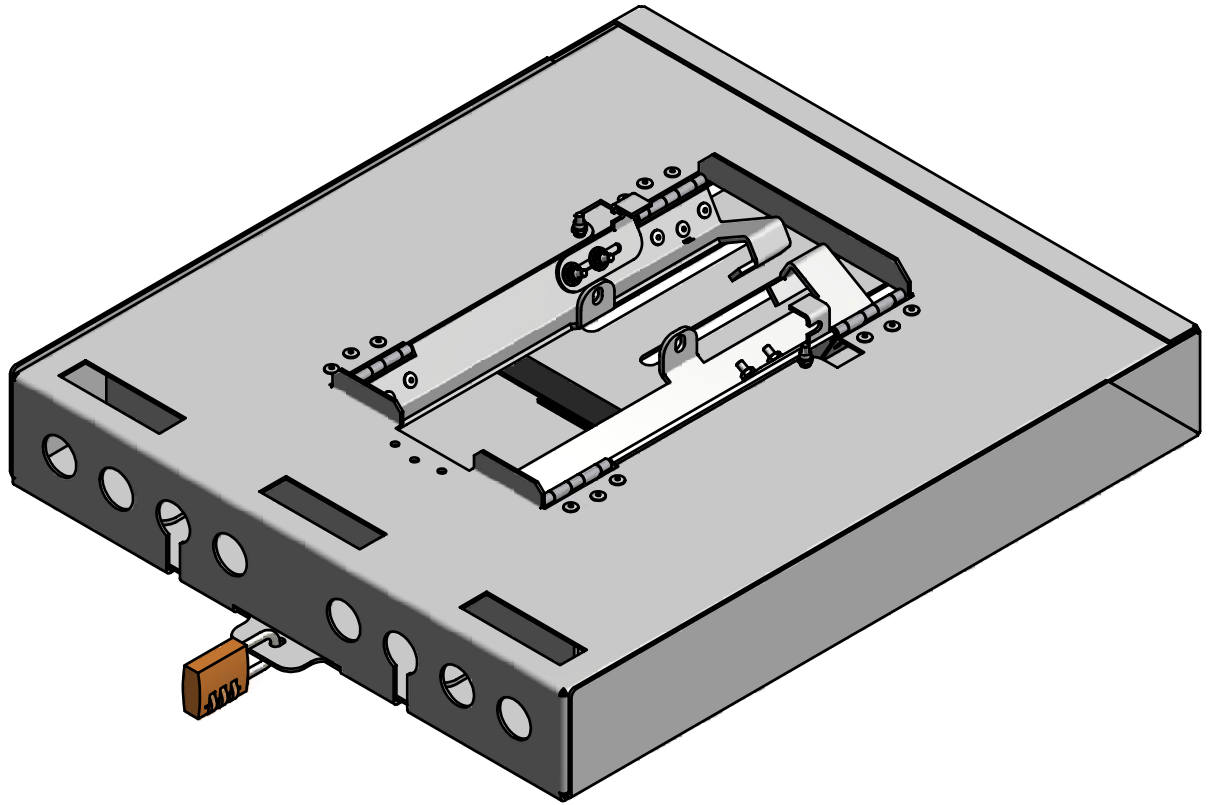

2.

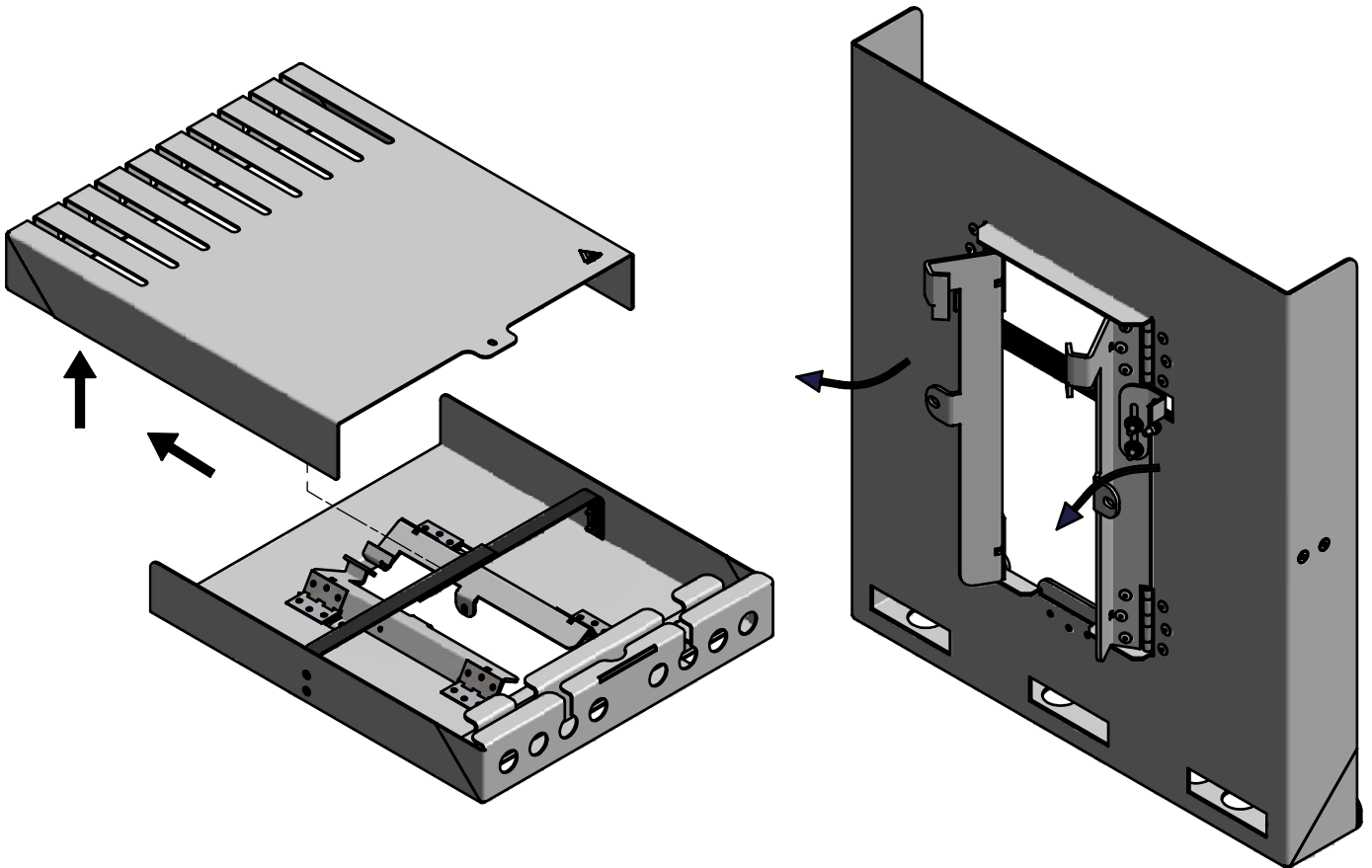

3.

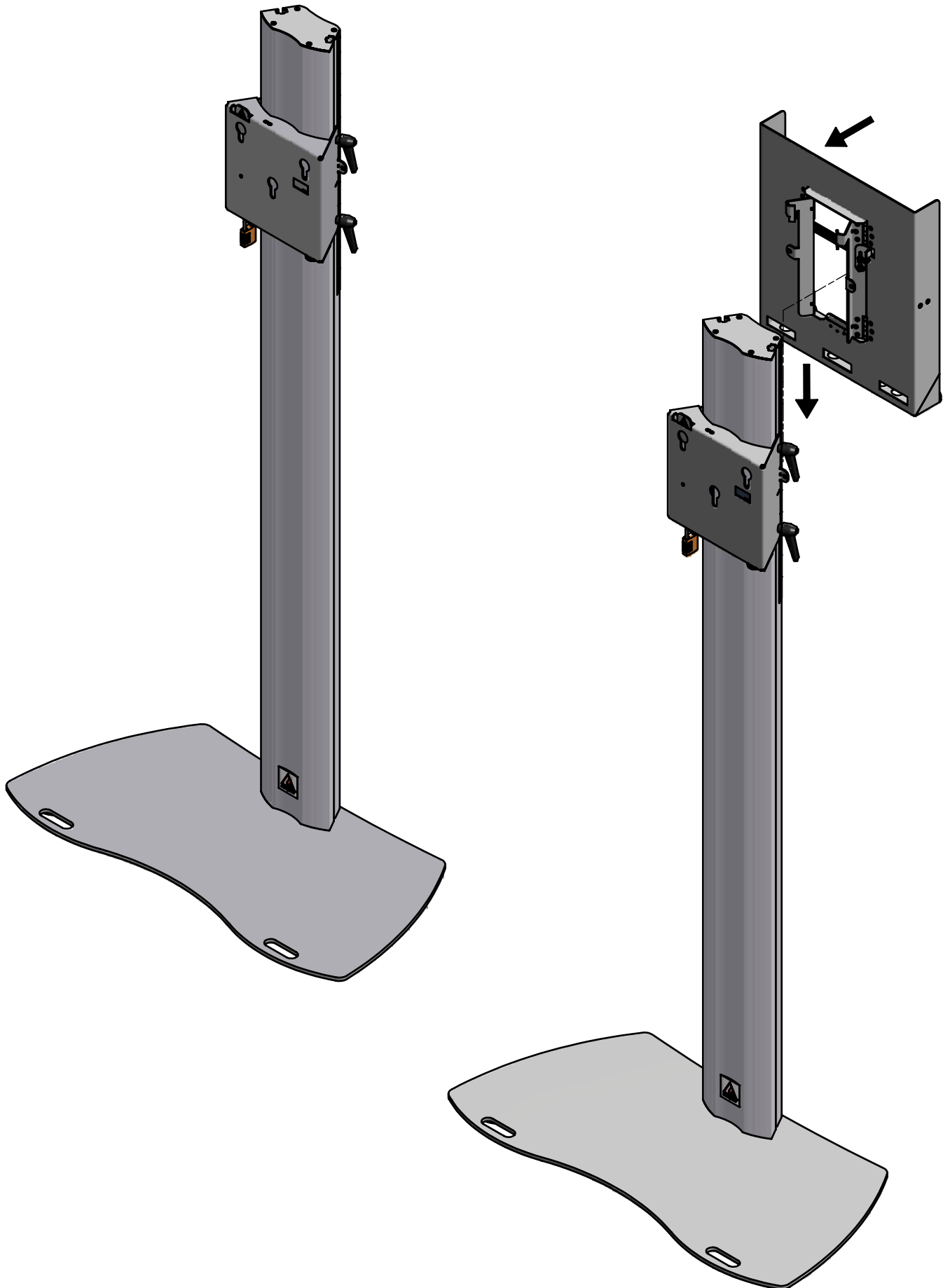

4.

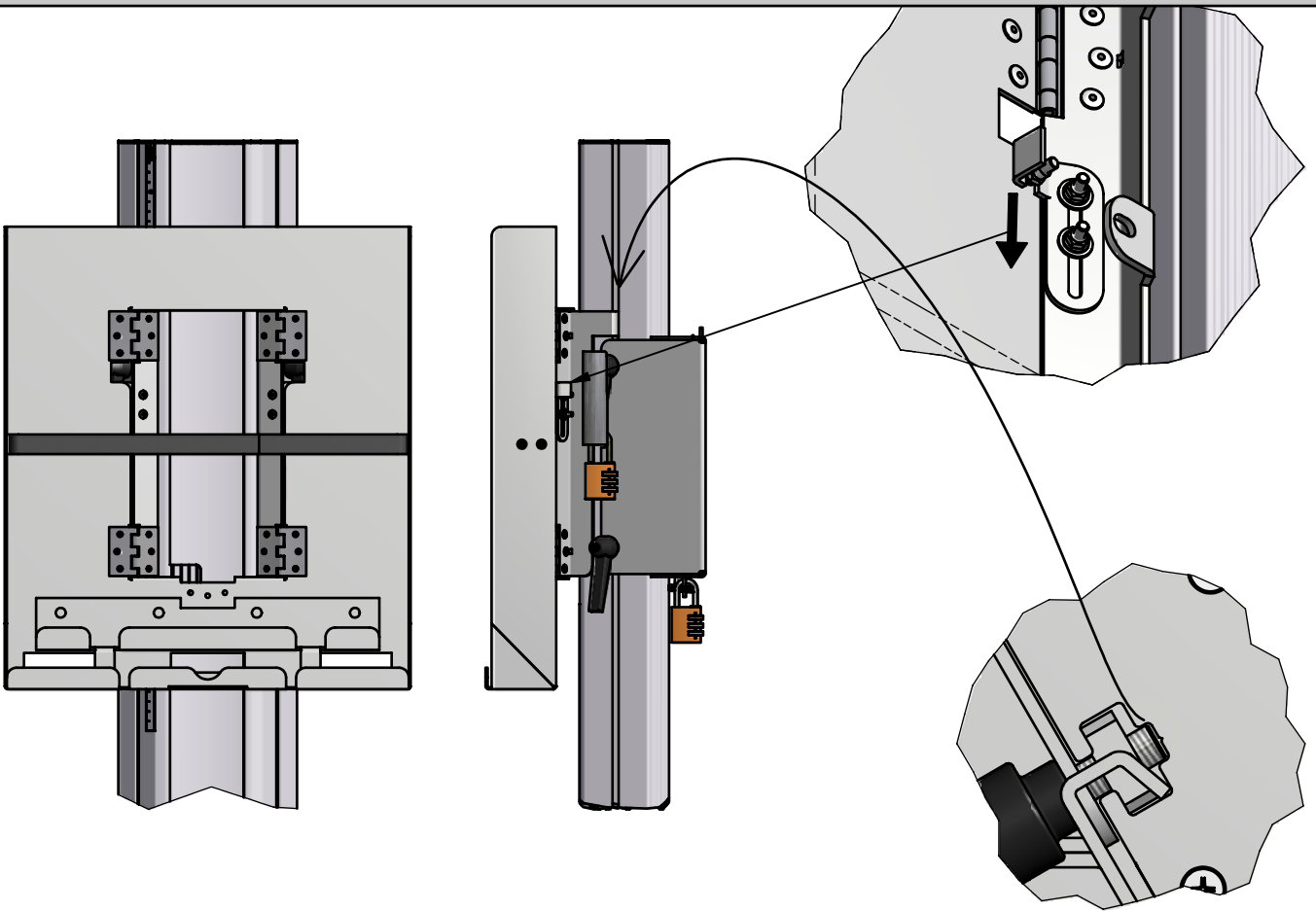

5.

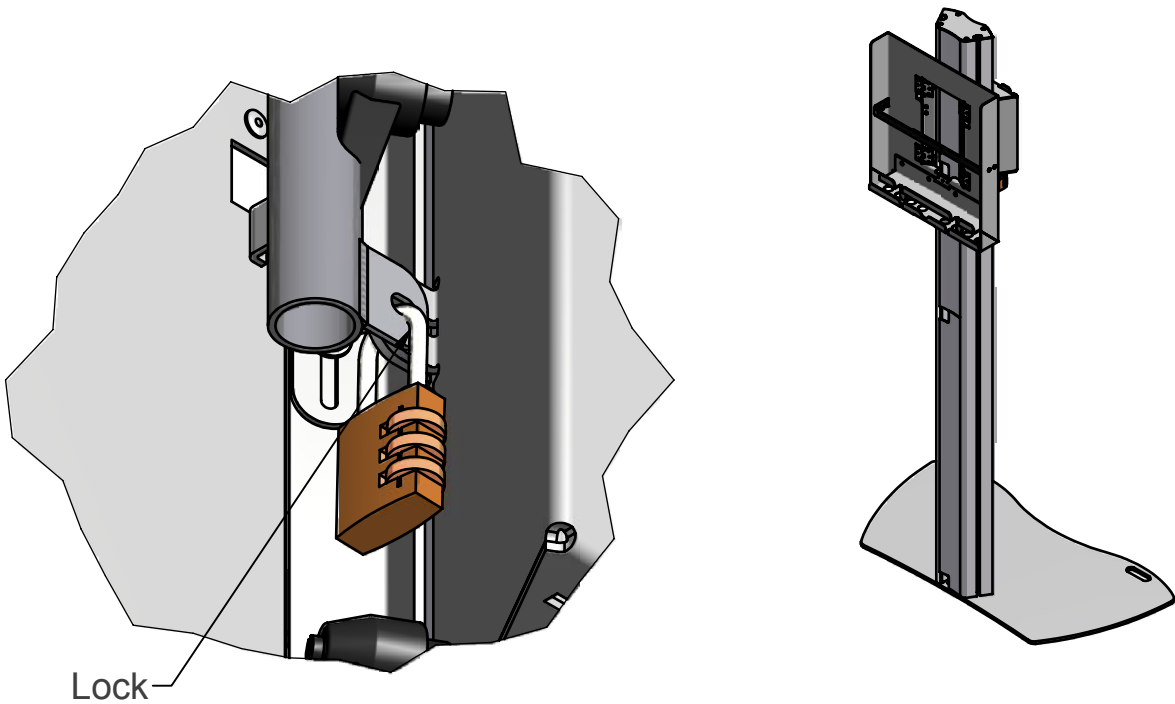

6.

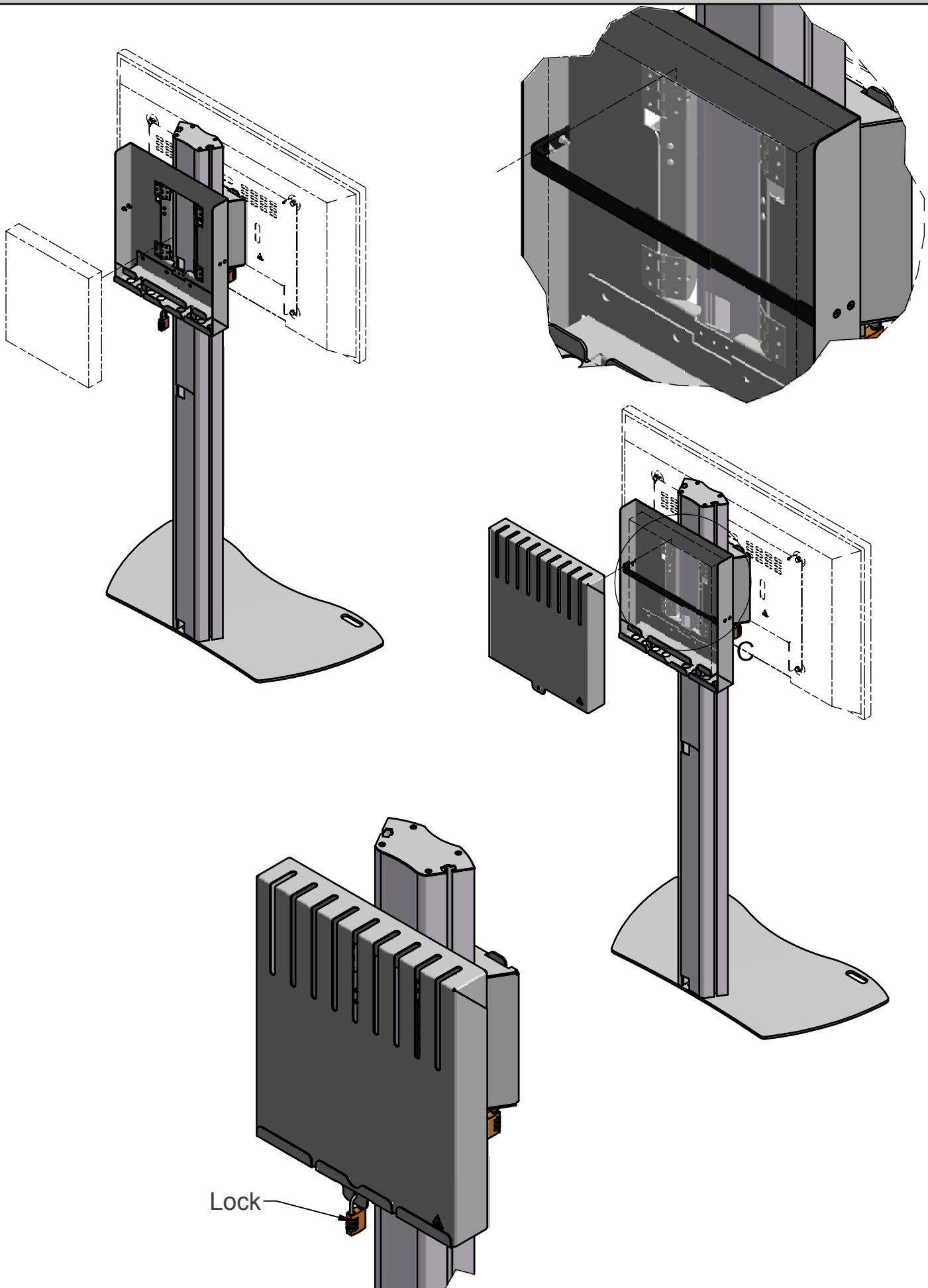

Audipack reserves the right to make changes in specifications and other information contained in this document without prior written notice. The information provided herein is subject to change without notice. In no event shall Audipack be liable for any incidental, special, indirect, or consequential damages whatsoever, including but not limited to lost profits, arising out of or related to this manual or the information contained herein, even if Audipack has been advised of, known, or should have known, the possibility of such damages.



AUDIPACK
Industriestraat 2-4
2751 GT Moerkapelle
the Netherlands
Tel: +31(0)795931671
Fax: +31(0)795933115
Email: audipack@audipack.com
www.audipack.com